

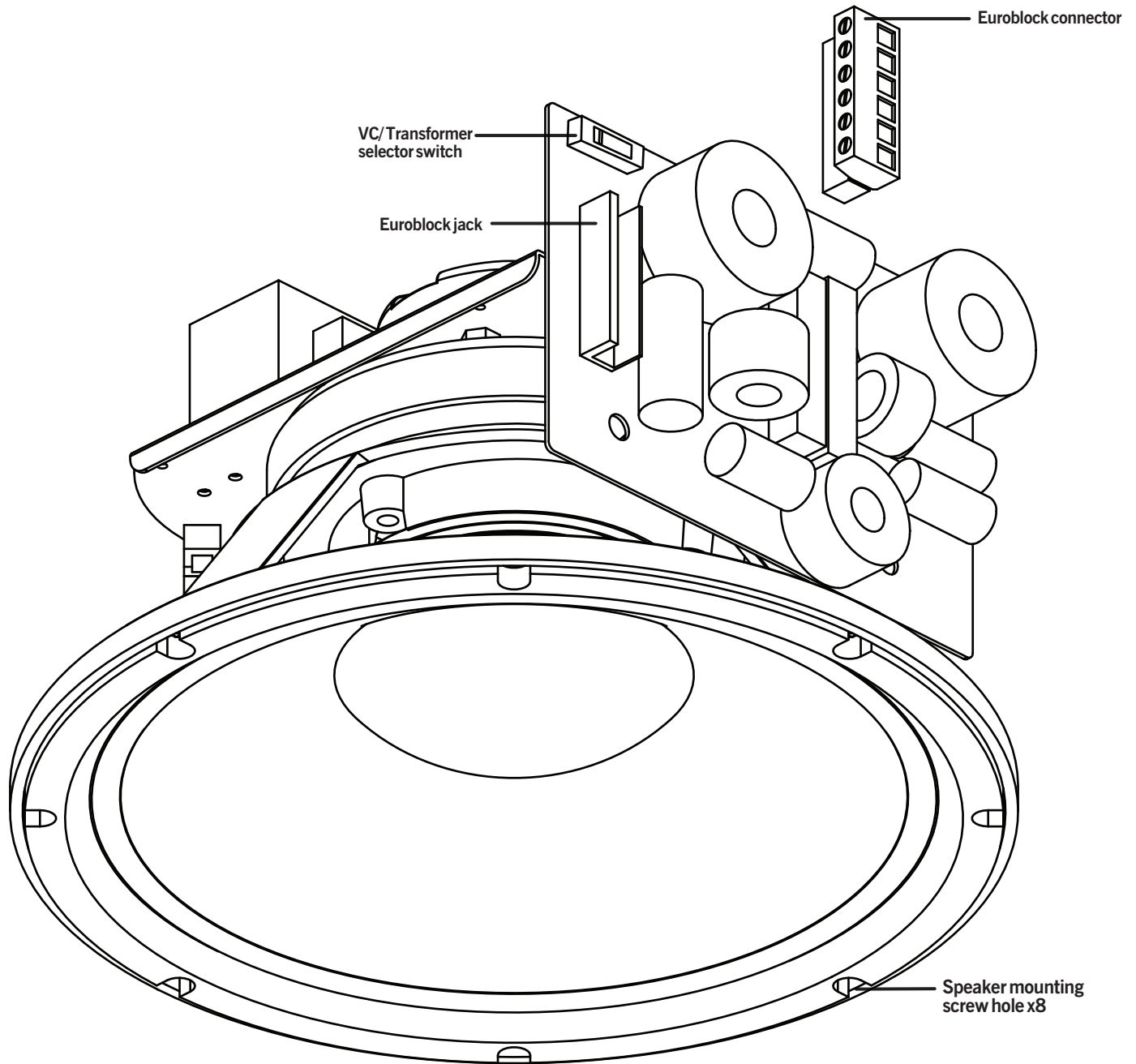

RF series

Install Instructions For:
RF122-150

Speaker will fit 2 cubic foot backcans/grilles from:
AMK, Atlas, Elkay, Lowell, Quam and others



Box contents

1 Speaker

1.435.647.9555 | 800.647.TUBE | www.soundtube.com

© 2007 SoundTube Entertainment, Inc. All rights reserved. PN INS-RF122-150 Rev 11.16.07

Warning

SoundTube speakers must be installed by a professional audio installer/contractor. For safety and for optimum audio performance, installer must follow all directions issued by SoundTube Entertainment.

Warning

Do not spec or install speaker near support beam, ventilation duct or other structure that may interfere with speaker function or dispersion.

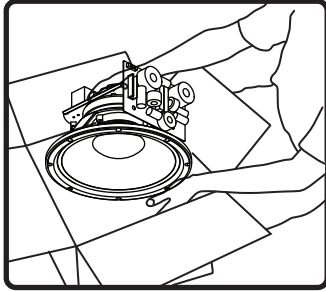

1. Unpack speaker.

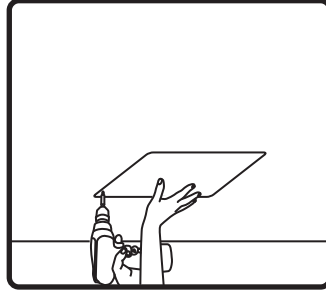

2. **Retrofit** - Remove old speaker from backbox and grille. Save grille nuts to reattach grille.

New Install - Install backbox following instructions provided by the manufacturer.

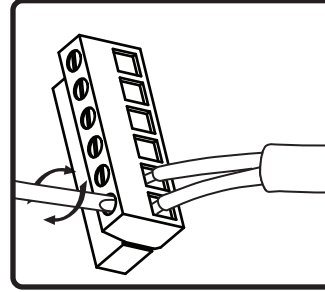

3. Connect signal wire to euroblock. Use diagram on speaker or at the bottom of this page to chose desired tap setting.

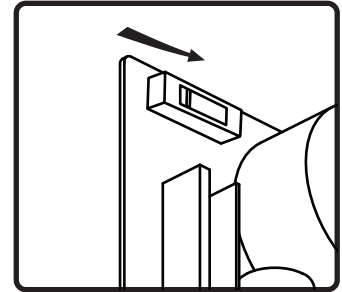

4. If using **8ohm/VC direct** set switch on top left of PC board to 8 Ohm mode.

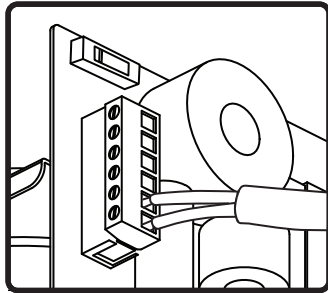

5. Connect euroblock to speaker.

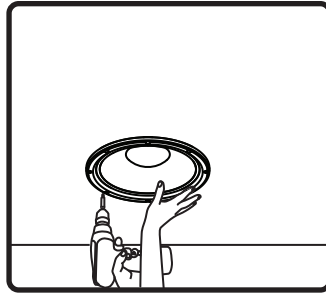

6. Insert speaker into backbox.

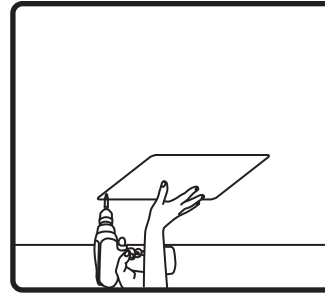

7. Attach grille

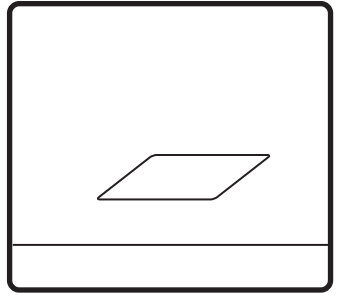

7. Done!

Tap setting Chart

SOUNDTUBE®

www.soundtube.com 1.435.647.9555

	1	2	3	4	5	6
100 v	Ω	x	150w	75w	38w	COM
70.7 v	Ω	150w	75w	38w	19w	COM
25 v	Ω	38w	19w	9.5w	4.8w	COM